

Assembly and Operation of the



ULTRASONIC INTRUSION ALARM

MODEL GD-39

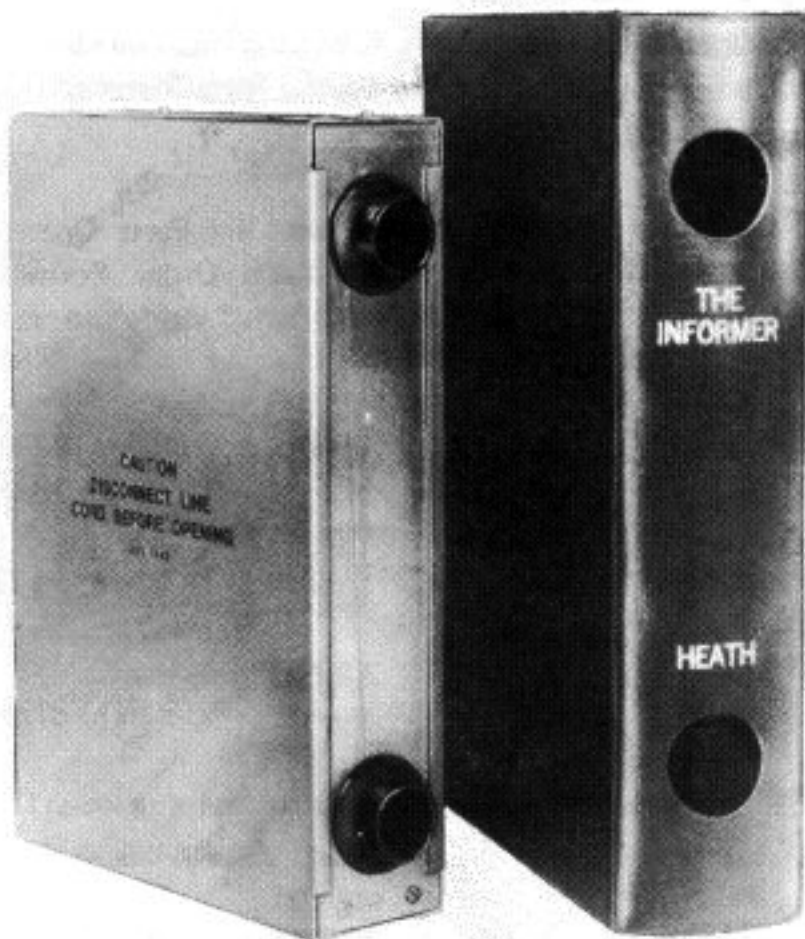
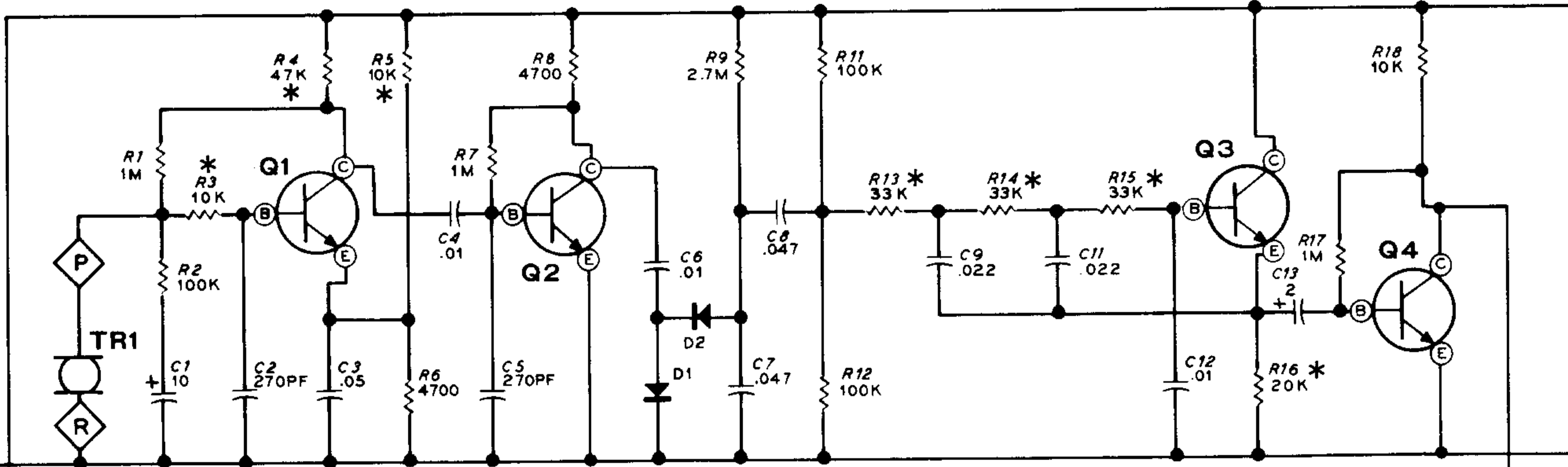
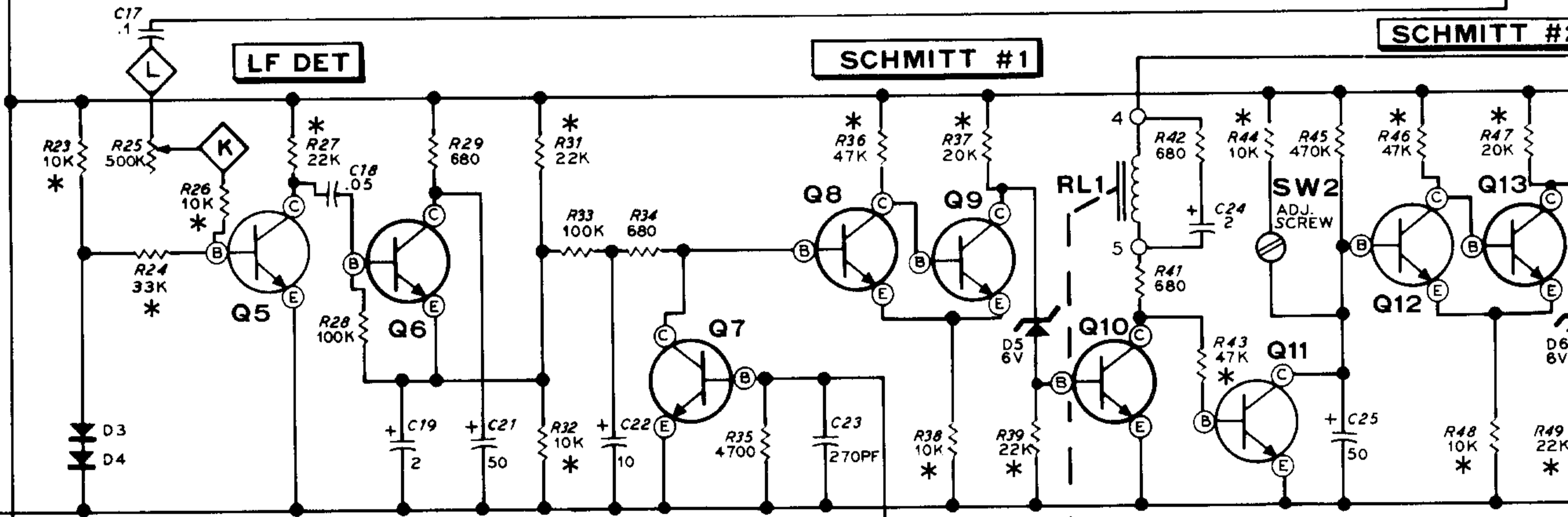
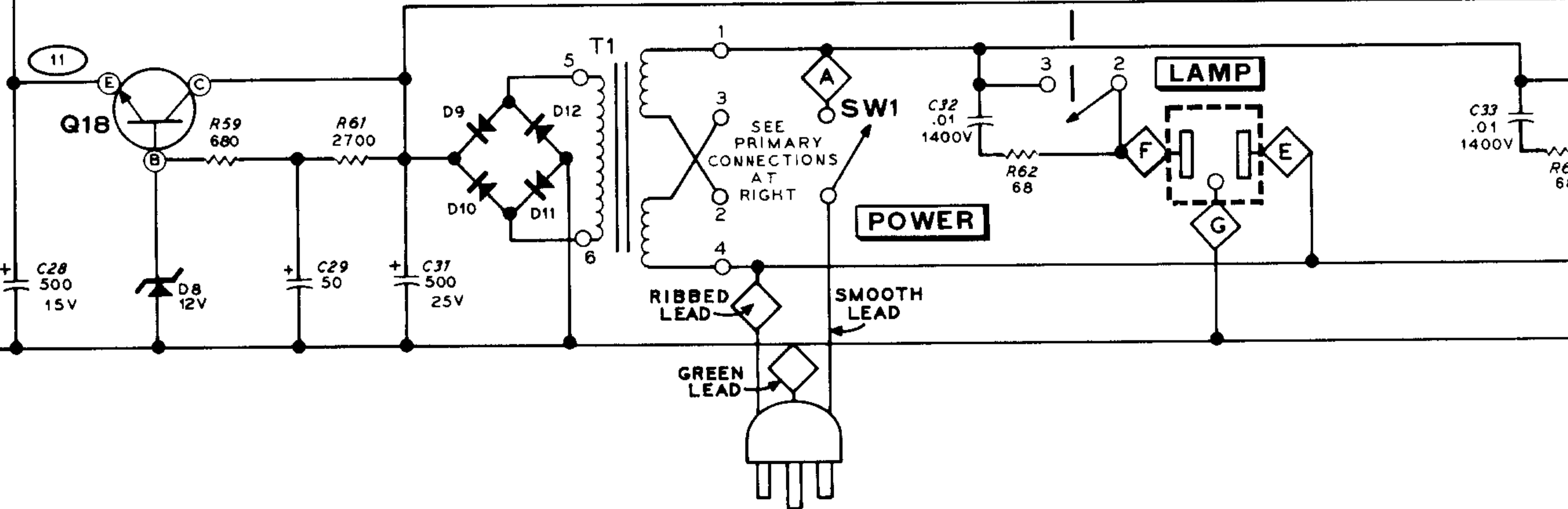
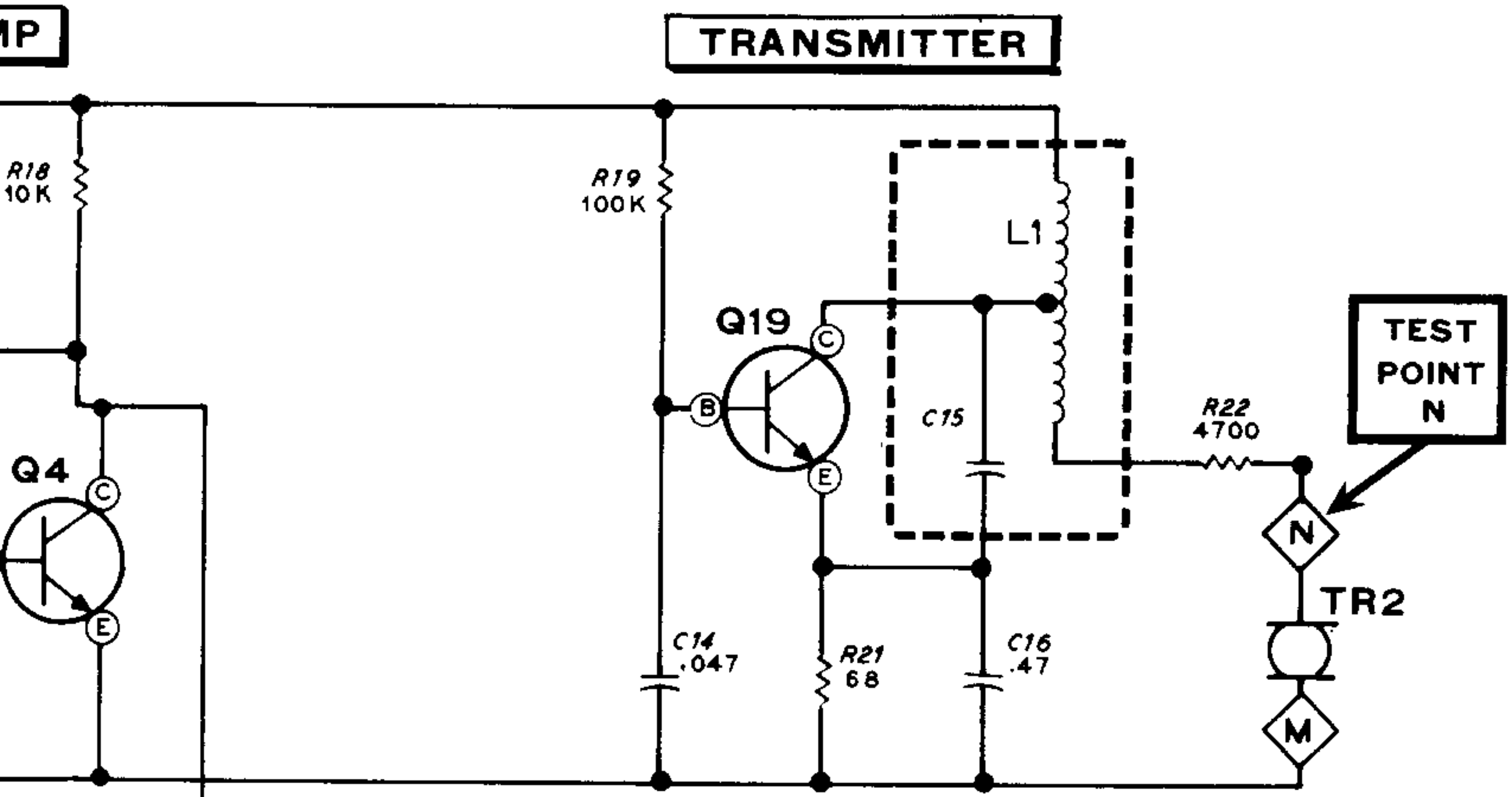

TABLE OF CONTENTS

Introduction	2
Parts List	2
Step-by-Step Assembly	4
Transformer Primary Wiring	14
Chassis Notes	15
Chassis Parts Mounting	15
Tests and Adjustments	20
Final Assembly	22
Installation	23
Operation	25
In Case of Difficulty	26
Troubleshooting Chart	27
Specifications	30
Circuit Description	31
Circuit Board X-Ray Views	33
Chassis Photograph	36
Voltage Charts	37
Schematic. . . (fold-out from page)	39
Warranty	Inside front cover
Customer Service	Inside rear cover

RECEIVER**LF AMP****LF DET****SCHMITT #1****SCHMITT #2****B+REGULATOR****POWER SUPPLY**



**SCHEMATIC OF THE
HEATHKIT®
MODEL GD-39
ULTRASONIC INTRUSION ALARM**

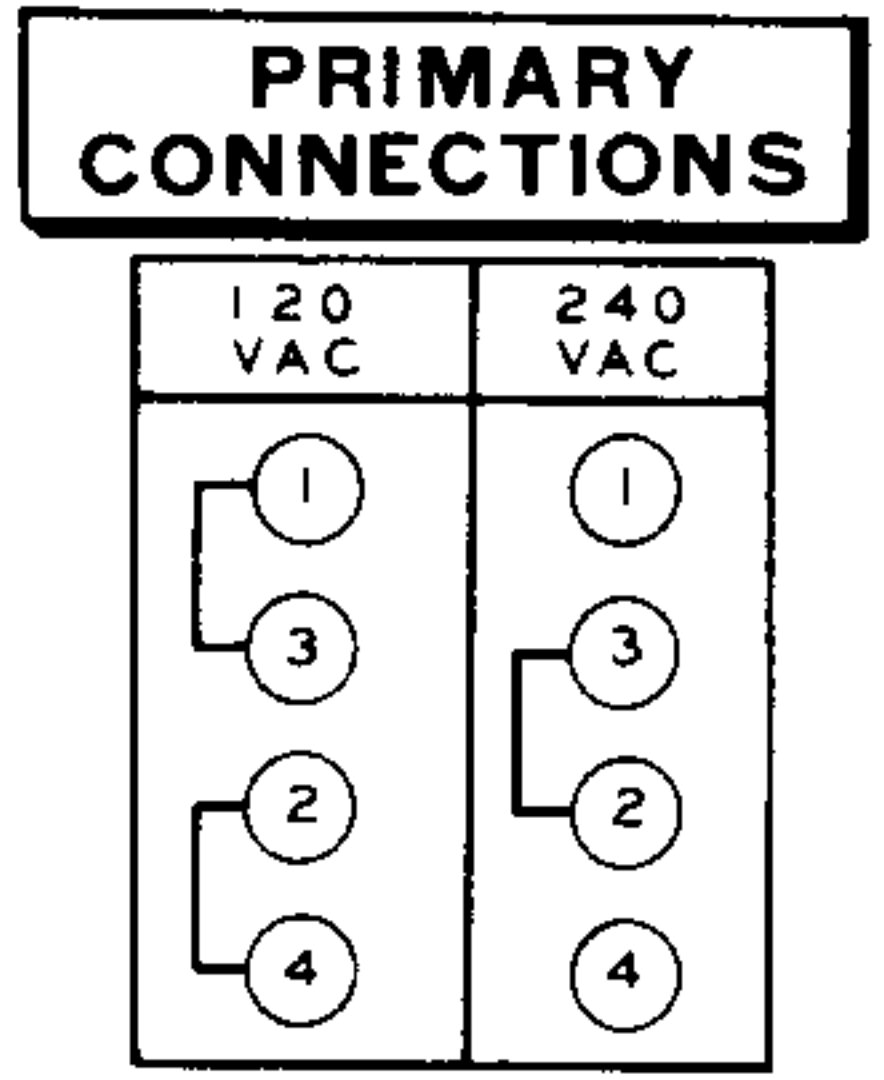
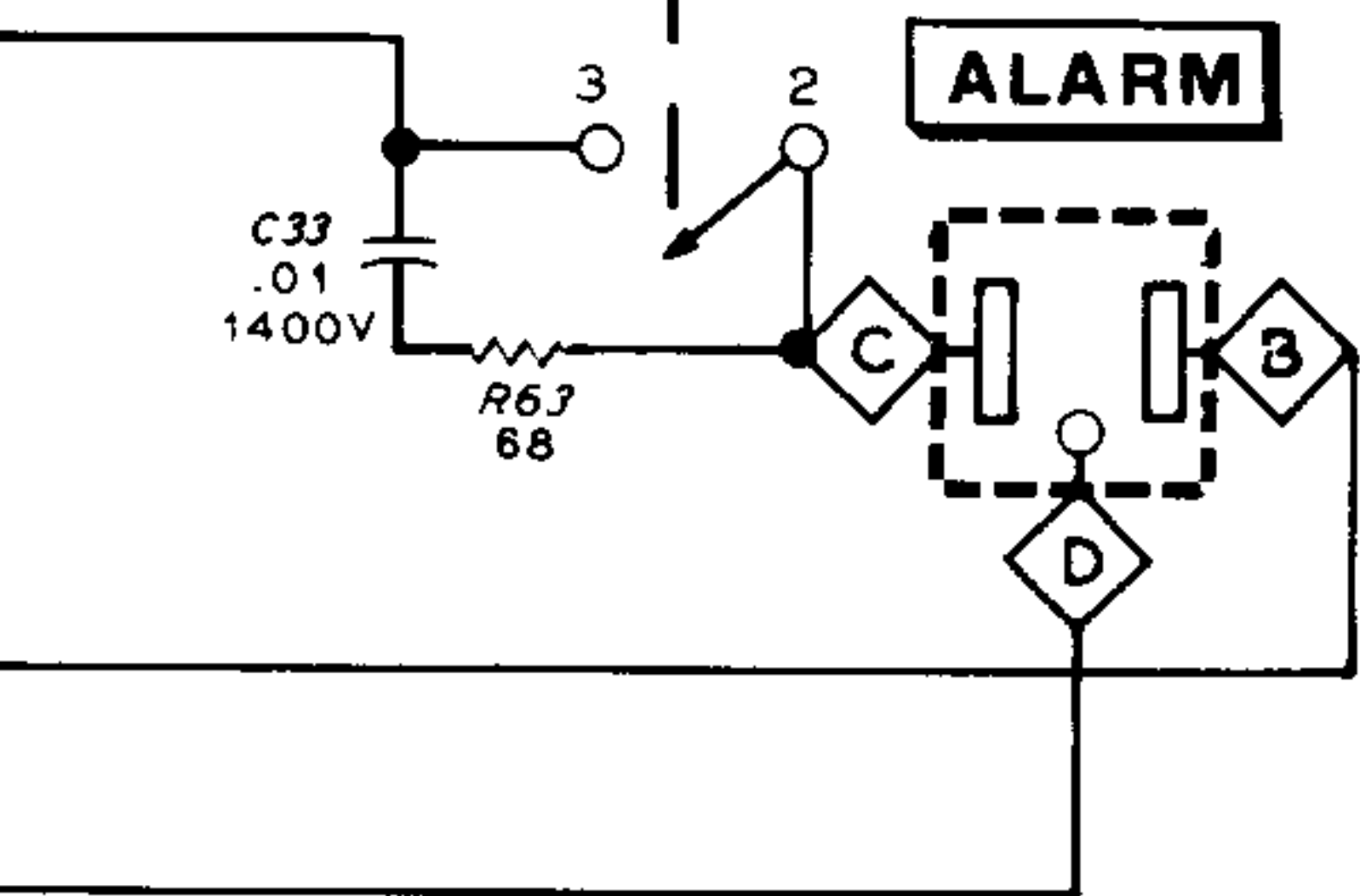
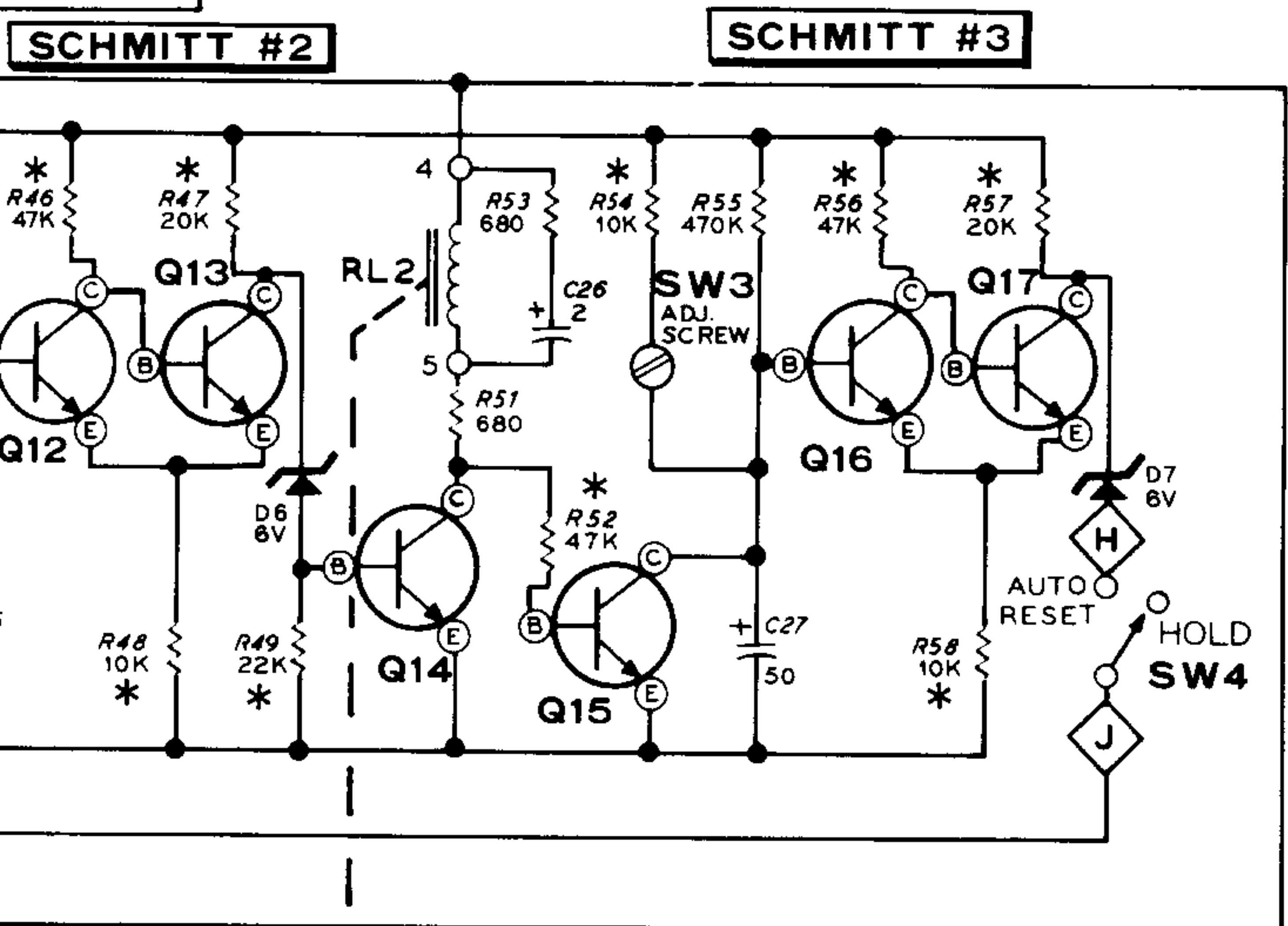

NOTES:

1. ALL RESISTORS ARE 1/2 WATT. RESISTOR VALUES ARE IN OHMS UNLESS OTHERWISE MARKED (K=1,000; M=1,000,000.) 5% TOLERANCE RESISTORS ARE MARKED WITH AN ASTERISK.
2. ALL CAPACITOR VALUES ARE IN µF UNLESS OTHERWISE MARKED.
3. SYMBOLS:
 - * 5% TOLERANCE RESISTORS (4th BAND GOLD)
 - ◊ A CIRCUIT BOARD CONNECTION HOLE. A LETTER IN THE SQUARE IS THE LETTER PRINTED ON THE CIRCUIT BOARD.
 - ◻ TRANSDUCER.
 - A DC VOLTAGE OF THE SAME VALUE AS THE CONTAINED FIGURE.
 - ⊏ AC SOCKET.
4. REFER TO THE TRANSISTOR AND DIODE IDENTIFICATION CHART FOR IDENTIFICATION INFORMATION OF THESE DEVICES.
5. REFER TO THE X-RAY VIEWS AND THE CHASSIS PHOTOGRAPHS FOR THE PHYSICAL LOCATION OF PARTS.
6. REFER TO THE VOLTAGE CHART FOR VOLTAGES AT TRANSISTOR BASES AND DIODE LEADS.